

# BT Series

## MicroBrite™ Backlights | Product Datasheet

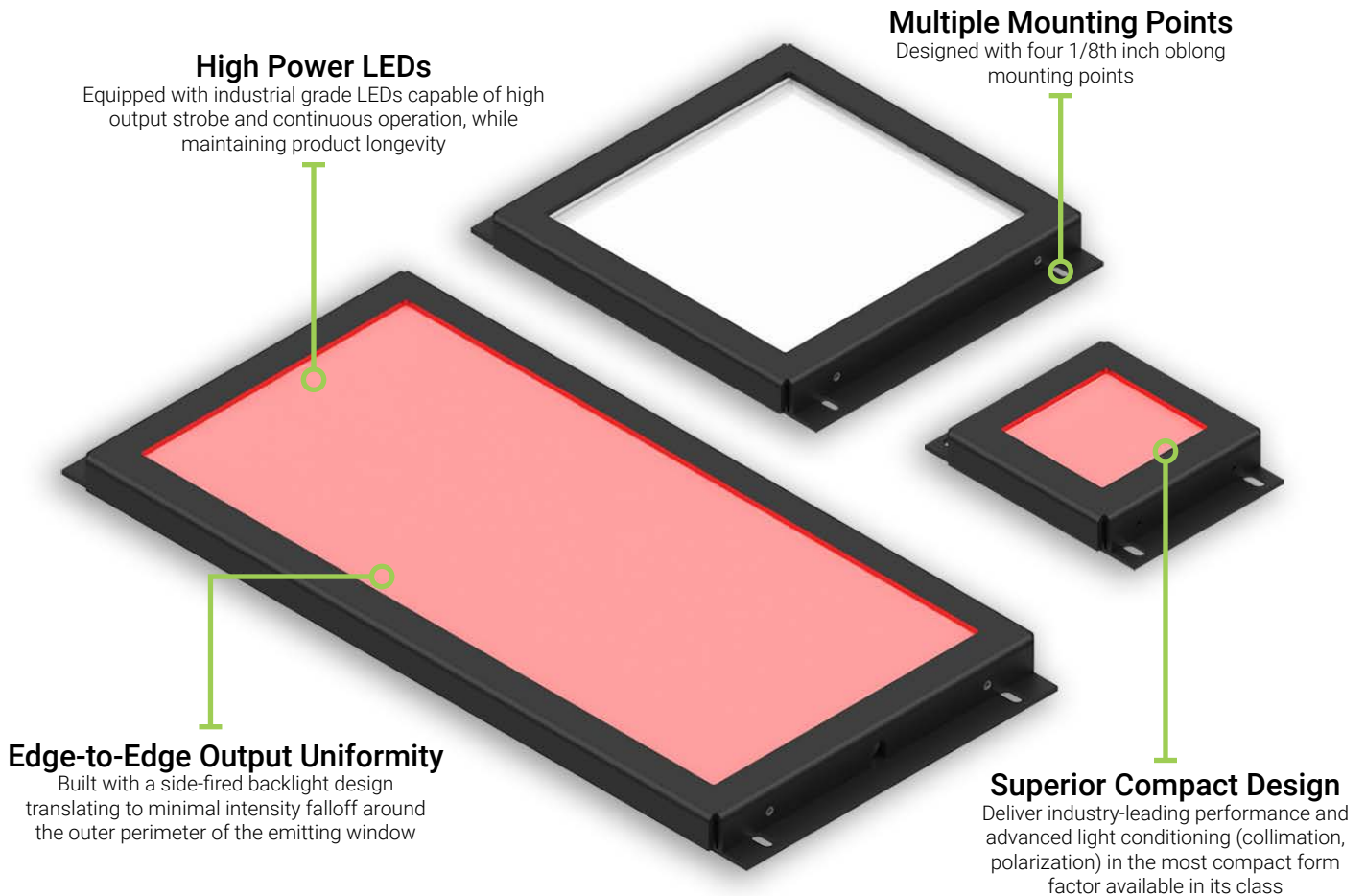

### BT Series Description

The BT Series, otherwise known as our MicroBrite™ Backlight Series, is specifically engineered to be extremely compact, while maintaining a high output intensity.

MicroBrite Backlights share a design similar to Ai's BX/CX series, utilizing light guide technology for edge-to-edge uniformity in a thin package. However, they are best suited for smaller backlight inspections due to their limited emitting window size availability.

As with most planar backlight designs, this product is useful for edge detection, part location & orientation identification, presence & absence, hole detection and object gauging.



**Compact**



**High Intensity**



**5 Wavelengths Available**



**Collimation and Polarization Available**



**1-2 Week BTO Lead Times**

**General Information**

**General Specifications**

| Category             | Specification                  | Detail  |        |   |                              |
|----------------------|--------------------------------|---|--------|---|------------------------------|
| <b>Optical</b>       | Available Wavelengths          | White, 455nm, 530nm, 625nm, 850nm   |        |   |                              |
|                      | Available Lensing              | No Lenses   |        |   |                              |
|                      | Available Light Conditioning   | Collimation, Polarizer  |        |   |                              |
| <b>Electrical</b>    | Power Consumption Info         | See Power Requirements on Page _  |        |   |                              |
|                      | Cable Info                     | 80" -0/+6" Long (2 m -0/+150 mm), 105 °C Rated, Foil Shield w/ Drain  |        |   |                              |
| <b>Mechanical</b>    | Sizing Info                    | Standard  | Length | 050050 - 2.76" (70.0 mm); 100100 - 4.53" (120.0 mm); 200100 - 8.66" (220.0 mm); | See Page 10 for More Details |
|                      |                                |   | Width  | 050050 - 2.15" (54.7 mm); 100100 - 4.12" (104.6 mm); 200100 - 4.12" (104.6 mm); |                              |
|                      |                                |   | Height | 0.43" (10.9mm)  |                              |
|                      | Weight Info (Standard)         | ~ 0.12 lbs (~54 g) per 50x50mm" Unit, ~ 0.43 lbs (~195 g) per 100x100mm" Unit, ~ 0.69 lbs (~313 g) per 200x100mm" Unit, |        |   |                              |
|                      | Mounting Info                  | 4x Ø.13" (Ø3.2mm) x .25" (6.4mm) OBROUNDS   |        |   |                              |
|                      | Material Info                  | Anodized Aluminum Housing, Acrylic Window, PVC Cable Jacket, Steel Black Oxide Fasteners                                |        |   |                              |
| <b>Thermal</b>       | Operating Case Temperatures    | 25 °C to 60 °C  |        |   |                              |
|                      | Operating Ambient Temperatures | 0 °C to 35 °C   |        |   |                              |
| <b>Certification</b> | Compliance                     | CE, RoHS, IEC 62471   |        |   |                              |
|                      | IP Rating                      | IP50  |        |   |                              |
|                      | Lumen Maintenance - White Only | L70 (50,000 Hours)  |        |   |                              |

**General Information - Continued**

**Part Number Key**

| Model                    | Model Extension | - | Peak Wavelength  | Connector/<br>Control | Light Conditioning<br>Option  | - | Alternative<br>Connector |
|--------------------------|-----------------|---|------------------|-----------------------|-------------------------------|---|--------------------------|
| BT                       | XXXXXX          | - | XXX              | XX                    | X                             | - | XXX                      |
| BT                       | 050050          |   | 455 (royal-blue) | C1                    | C (Collimation)               |   | M12 <sup>1</sup>         |
|                          | 100100          |   | 530 (green)      | C5                    | P (Polarization) <sup>2</sup> |   | M8 <sup>1</sup>          |
|                          | 200100          |   | 625 (red-orange) | IC                    |                               |   |                          |
|                          |                 |   | 850 (IR)         | I3                    |                               |   |                          |
|                          |                 |   | WHI (white)      | I3S                   |                               |   |                          |
| more information on page | 10              |   | 5                | 11                    | 6                             |   | 13                       |

**Example Part Numbers:**

BT050050-WHIC1  
BT200100-625IC

<sup>1</sup> Available with IC, I3, and I3S

<sup>2</sup> 455 (royal-blue) will reduce the life of the polarizer if selected

**In Stock**

Unavailable

**Lead Times**

Build-to-Order custom products ship within one to two weeks.

**Configurator**

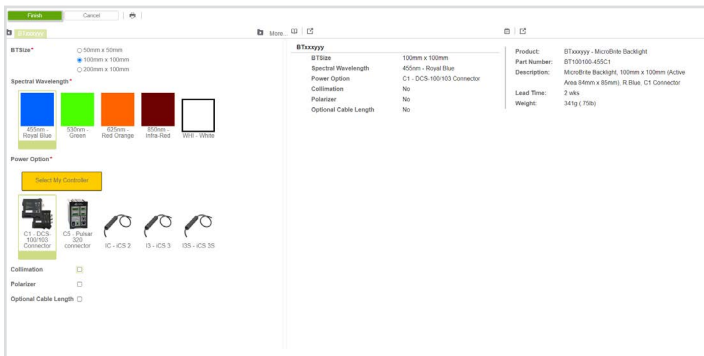

Need a build-to-order custom lighting solution in 2 weeks or less? Advanced Illumination's online configurator helps you tailor our BT MicroBrite Backlight Series to your specific needs. For a guided configuration, [visit our online configurator](#).

**Optical Information**

**Intensity Distribution**

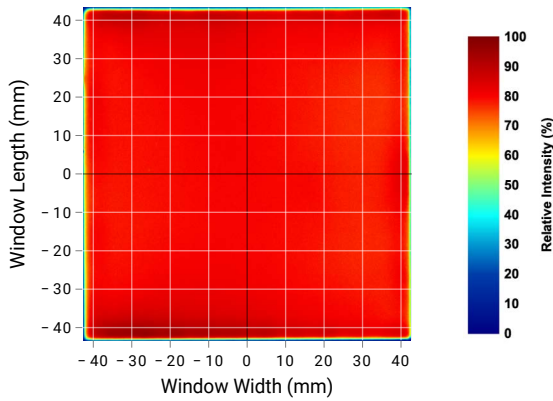

**Uniformity Profile Plot**

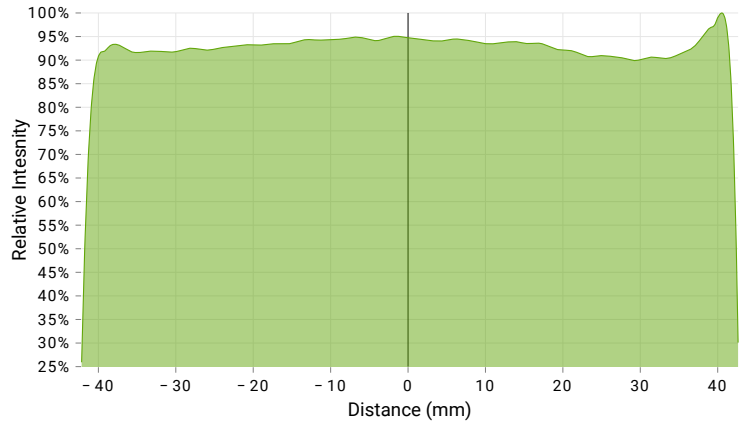

The BT Series provides a highly uniform output across its emitting window with practically no edge effect, and a uniformity of +/- 10% within the optical area.

Note: The optical data shown above has been sampled from a 100mm x 100mm white BT unit (BT1001000-WHIC) at the emitting surface.

**Continuous vs Strobe Intensity**

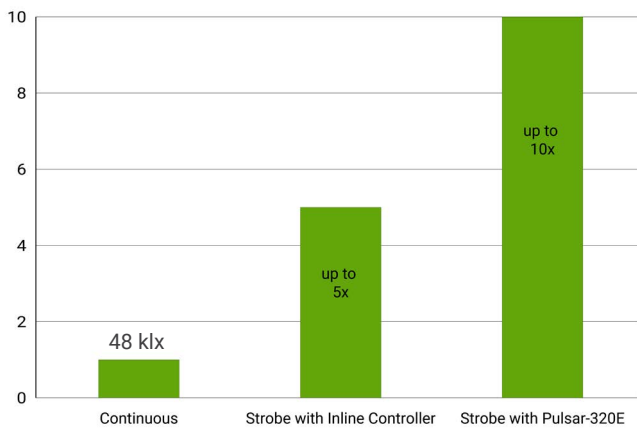

Under continuous operation, a 100mm x 100mm white BT unit will output an **illuminance of 48 klx** and an **irradiance of 137 W/m<sup>2</sup>** at the emitting surface. For applications that require higher output, the BT Series has been engineered to be overdrive strobe capable. When configured with AI's strobe enabled Inline Controller (I3, I3S, and I4), the BT is capable of outputting up-to 5X continuous levels. When configured with a C5 connector, compatible with AI's Pulsar 320E, a BT can be strobed up-to 10X continuous intensity levels.

Disclaimer: The measurements provided above are for approximations only and may vary depending on the method of measurement and the specific configuration being measured.

**Optical Information - Continued**

**White Spectral Profile**

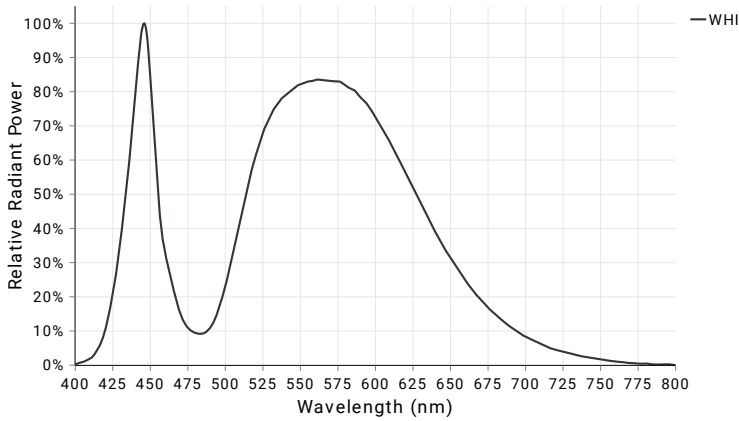

White LED illumination is the most commonly used machine vision lighting configuration. It is often the default choice when specific features of interest do not require color-based highlighting. However, **white LEDs can vary in color temperature between different lighting families, which can impact machine vision systems**, specifically when matching white light sources.

The BT Series white LEDs have a relatively neutral color correlated temperature (CCT) of **5500k**.

For a more detailed look at the white spectral data, download the [csv file of the raw spectral values](#) and refer to our [Product Spectra Distribution Charts PDF](#).

**Visible Spectral Profiles**

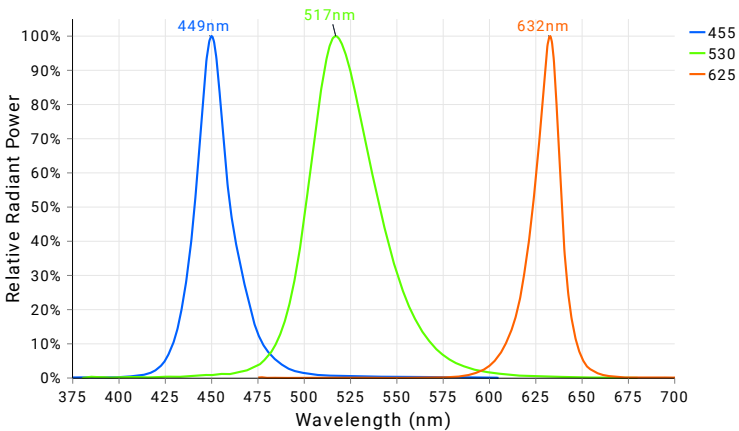

Visible color illumination consists of using wavelengths between 400-700 nm to either create or eliminate contrast on an inspection subject based on differences in a features color hue. When referring to a color wheel, simply remember the following: like colors reflect and brighten surfaces; conversely, opposing colors absorb and darken surfaces.

The BT Series is available in **455nm, 530nm, and 625nm** configurations.

For a more detailed look at the visible color spectral data, download the [csv file of the raw spectral values](#) and refer to our [Product Spectra Distribution Charts PDF](#).

**Non-Visible Spectral Profiles**

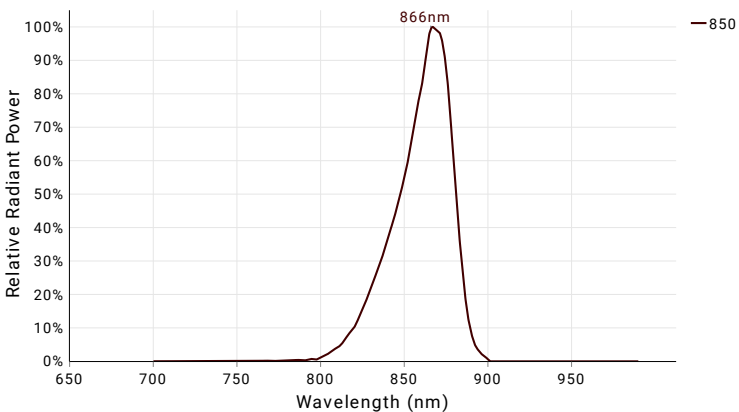

Near-infrared (NIR) imaging is a machine vision technique using longer wavelengths of 700-1000 nm to penetrate specific materials that are otherwise opaque to under the visible spectrum. When paired with a NIR camera, a NIR light can be ideal for applications such as fill level inspection, circuit board inspection, food safety inspection, and medical imaging.

The BT Series is available in an **850nm** configuration.

For a more detailed look at the NIR spectral data, download the [csv file of the raw spectral values](#) and refer to our [Product Spectra Distribution Charts PDF](#).

Disclaimer: The measurements provided above are for approximations only and may vary depending on the method of measurement and the specific configuration being measured.

**Optical Information - Continued**

**Collimation Option Detail**

**Non-collimated**

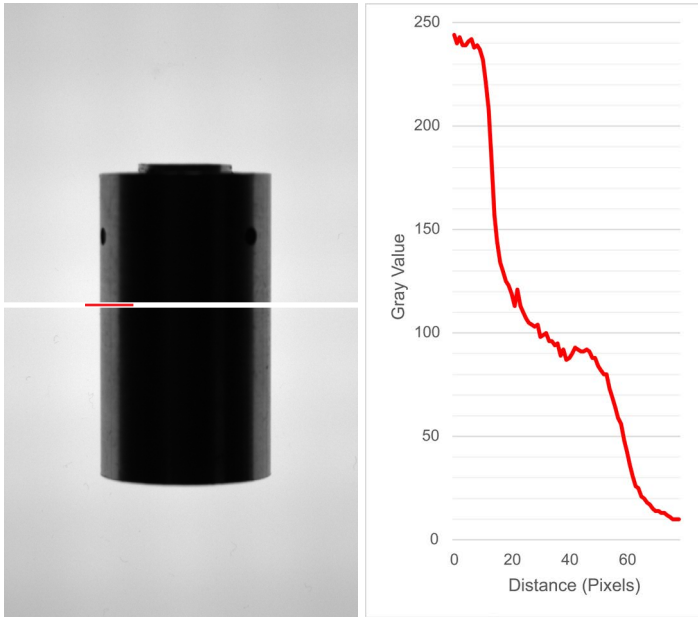

**Collimated**

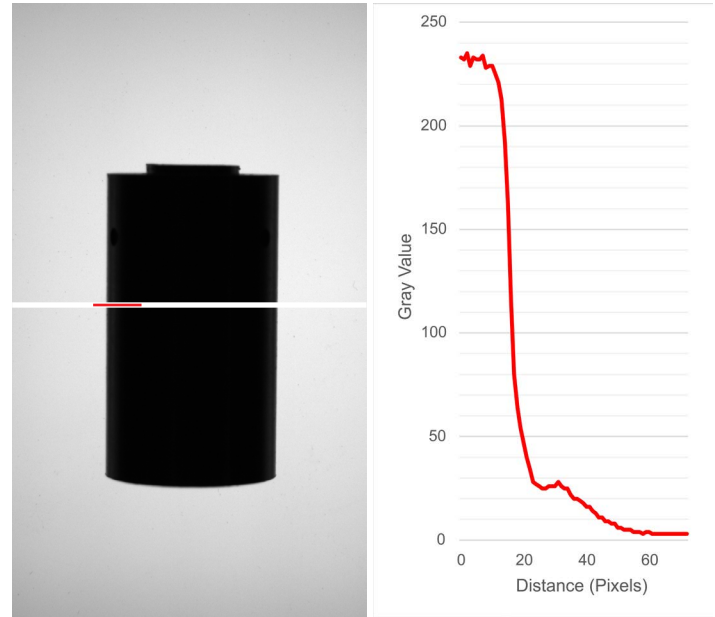

The BT Series is available for configuration with collimation as an option. This light conditioning option allows for **greater edge clarity** by collimating photons to travel parallel with the surface normal of the emitting window, diminishing dispersion, and creating a cleaner silhouette. This especially becomes useful when backlighting curved specular objects like the one shown above. On the left side, the edge clarity of the curved object (shown with a profile plot) is insufficient due to the highly diffuse nature of the backlight. On the right side, the edge clarity shows significant improvement with the addition of the collimated light conditioning.

**Polarization Option Detail**

**Non-polarized**



**Cross Polarized**



The BT Series also comes with the option for configuration with a polarization film. Polarization can be used in a variety of ways, such as reducing glare on specular surfaces or increasing edge clarity of transparent injection-molded objects, as shown above, also known as cross-polarization. When unpolarized light passes through two cross-polarized filters (oriented 90 degrees perpendicular to each other), it is completely blocked. However, if the light is already polarized, it will only be blocked if its polarization is perpendicular to the axis of the second polarizer, creating the cross-polarization effect shown above.

Disclaimer: The measurements provided above are for approximations only and may vary depending on the method of measurement and the specific configuration being measured.

**Optical Information - Continued**

**Photobiological Risk Factors**

| Group   | Description   | Affected Wavelengths   |
|---------|---|------------------------|
| Exempt  | No Photobiological Hazard   | 850 nm                 |
| Group 1 | No Photobiological hazard under normal behavioral limitations                         | 470 nm, 530 nm, 625 nm |
| Group 2 | Does not pose a hazard due to aversion response to bright light or thermal discomfort | White                  |

Advanced Illumination's lighting products have been tested and classified to IEC standards by accredited testing services. For more information on our of photobiological risk factors, please view the following PDF: <https://www.advancedillumination.com/wp-content/uploads/2019/04/IEC-040119.pdf>

**Cleaning Guidelines**



To clean our light's optics, it is best to only clean when necessary. Dusting is always the first step in cleaning your optics. Wiping a dusty optic is like cleaning it with sandpaper. So always dust with a canned air duster or compressed and filtered air before wiping any optic. If the dusted optic has no visible stains after you dust it, then remember: "If it's not dirty, don't clean it." Avoid wiping optics when possible.

If dusting did not clean the lens or the lens has stains, use only de-ionized water and mild dish soap with a low lint cloth designed for optics to avoid damage to the optic by any harsh chemicals.

Polarizers, beam splitters and collimated films should never be wiped with any type of cloth or solvent, only use the air dusting method to clean these types of optics.

The aluminum housing can be wiped down when dusting is not a sufficient means to thoroughly clean.

**Backlight Comparison Matrix**

Not finding the optical specifications you are looking for with the BT Series? Refer to the backlight comparison matrix below to compare and contrast Advanced Illumination's comprehensive product offering:

| Attributes                              | Planar Backlights  |  |  |                       | Linear Backlights / High Diffusion Bar Lights |                        |                        |                       |                       |
|---|--|--|--|-----------------------|---|------------------------|------------------------|-----------------------|-----------------------|
|   | BL2  | BX/CX  | BT   | BL245                 | BL313   | BL138                  | BL168                  | BL128                 | BL193                 |
| Emitting Window Surface Intensity       | 86 klx   | 35 klx<br>(200 mm x 200 mm unit)               | 48 klx<br>(100 mm x 100 mm unit)               | 86 klx                | 231 klx                                       | 542 klx                | 567 klx                | 51 klx                | 12 klx                |
|   | 249 W/m <sup>2</sup>   | 105 W/m <sup>2</sup><br>(200 mm x 200 mm unit) | 137 W/m <sup>2</sup><br>(100 mm x 100 mm unit) | 249 W/m <sup>2</sup>  | 735 W/m <sup>2</sup>                          | 1,642 W/m <sup>2</sup> | 1,760 W/m <sup>2</sup> | 173 W/m <sup>2</sup>  | 41 W/m <sup>2</sup>   |
| Emitting Window Surface Edge Effect     | 0.681 in<br>(17.3 mm)  | 0 in<br>(0mm)                                  | 0 in<br>(0mm)                                  | 0.724in<br>(18.4mm)   | 0.987in<br>(25.1mm)                           | 0.343in<br>(8.7mm)     | 0.429in<br>(10.9mm)    | 0.634in<br>(16.1mm)   | 1.524in<br>(38.7mm)   |
| 100 mm Working Distance Intensity       | N/A  | N/A  | N/A  | N/A                   | 22 klx  | 48 klx                 | 50 klx                 | 9 klx                 | 1 klx                 |
|   |  |  |  |                       | 74 W/m <sup>2</sup>                           | 153 W/m <sup>2</sup>   | 164 W/m <sup>2</sup>   | 32 W/m <sup>2</sup>   | 4 W/m <sup>2</sup>    |
| 100 mm Working Distance FWHM            | Longitudinal: ~12 in (~300 mm)<br>Transversal: ~6 in (~150 mm) |  |  |                       |   |                        |                        |                       |                       |
| Minimum Bezel Thickness                 | 0.465 in<br>(11.8 mm)  | 1.265 in<br>(32.1 mm)                          | 0.380 in<br>(9.65 mm)                          | 0.215 in<br>(5.46 mm) | 0.125 in<br>(3.18 mm)                         | 0.050 in<br>(1.27 mm)  | 0.050 in<br>(1.27 mm)  | 0.00 in<br>(0.00 mm)  | 0.065 in<br>(1.65 mm) |
| Maximum Light Thickness                 | 0.940 in<br>(23.9 mm)  | 0.75 in<br>(19.0 mm)                           | 0.420 in<br>(10.7 mm)                          | 0.950 in<br>(24.1 mm) | 0.850 in<br>(21.6 mm)                         | 3.570 in<br>(90.7 mm)  | 3.570 in<br>(90.7 mm)  | 0.480 in<br>(12.2 mm) | 1.180 in<br>(30.0 mm) |
| Largest Possible Emitting Window Length | 46 in<br>(1168 mm)   | 24 in<br>(610 mm)                              | 8 in<br>(204 mm)                               | 12 in<br>(305 mm)     | 20 in<br>(508 mm)                             | 96 in<br>(2438 mm)     | 96 in<br>(2438 mm)     | 14 in<br>(356 mm)     | 80 in<br>(2032 mm)    |
| Sizes Available                         | 736  | 576  | 3  | 144                   | 10  | 17                     | 17                     | 14                    | 80                    |
| Visible Wavelengths Available           | 4  | 4  | 4  | 4                     | 6   | 4                      | 1                      | 4                     | 4                     |
| IR Wavelengths Available                | 1  | 1  | 1  | 1                     | 2   | 1                      | 0                      | 1                     | 1                     |
| RGB Available                           | No   | No   | No   | No                    | No  | Yes                    | No                     | No                    | No                    |
| Collimation Available                   | Yes  | Yes  | Yes  | No                    | No  | No                     | No                     | No                    | No                    |
| Polarization Available                  | Yes  | Yes  | Yes  | No                    | No  | No                     | No                     | No                    | No                    |
| IP Rating                               | IP50   | IP50   | IP50   | IP69K Certified       | IP50  | IP50                   | IP50                   | IP50                  | IP50                  |
| Price                                   | \$\$\$   | \$\$   | \$\$\$   | \$\$\$\$              | \$\$  | \$\$\$                 | \$\$\$                 | \$\$\$                | \$                    |

To ensure consistent comparisons, all data presented above is based on 12-inch white LED models unless explicitly stated otherwise. This corresponds to 12 inches by 12 inches (300 mm x 300 mm) in length as well as width for planar backlights and 12 inches in length for linear backlights. Additionally, all measurements provided above are derived from "standard" configurations, excluding sealed models if available as optional.

If you are still not finding the optical specifications needed for your application, [inquire](#) about our semi-custom and full-custom capabilities.

Disclaimer: The measurements provided above are for approximations only and may vary depending on the method of measurement and the specific configuration being measured.



**Backlight Comparison Matrix - Definitions**

For definitions on the terminology used on the previous page, please refer to the table below:

| Definitions                         |                                |
|-------------------------------------|--------------------------------|
| Emitting Window Surface Edge Effect | FWHM (Full Width Half Maximum) |

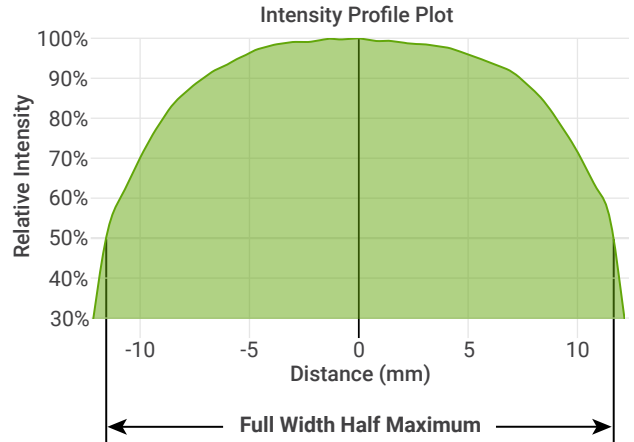
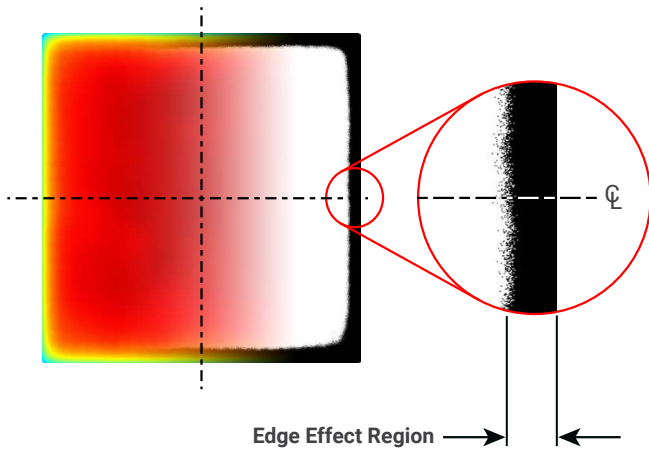

Edge Effect refers to the decrease in light intensity along the outer perimeter of a backlight's emitting surface. It's characterized by the region where the intensity falls below 80% of the peak value. For linear backlights, edge effect is measured along the length of the light. We recommend users avoid this region when sizing a backlight for their application.

FWHM (Full Width Half Maximum) is a measure of the width of a light source's intensity distribution. Specifically, it defines the distance between the points on the intensity profile where the light intensity drops to 50% of its peak value. This FWHM distance is often used to determine the usable FOV (Field of View) when aiming a light at a surface for inspection.

| Bezel Thickness | Light Thickness |
|-----------------|-----------------|
|-----------------|-----------------|

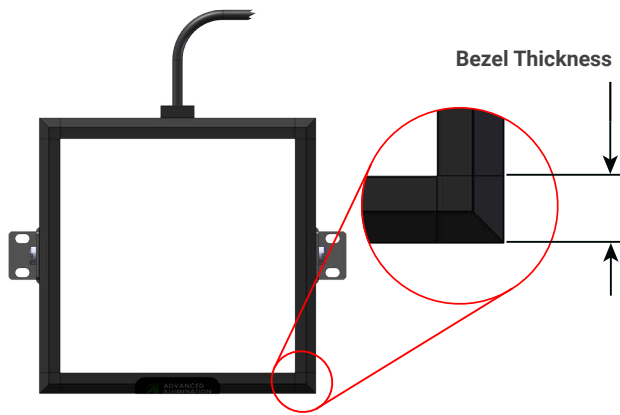

Bezel Thickness refers to the width of the non-illuminated border or frame surrounding the light-emitting surface of a machine vision backlight. Bezel thickness is an important consideration when integrating a backlight into a tight space, as it directly affects how close you can place the light-emitting surface to an object on its side.

Light Thickness refers to the overall depth of a machine vision backlight, measured from the back of the unit to the front of the light-emitting surface. A thinner light thickness is critical in applications with limited space constraints, allowing flexible integration into tight machine vision setups.

Disclaimer: The measurements provided above are for approximations only and may vary depending on the method of measurement and the specific configuration being measured.

**Mechanical Information**

**Installation Drawings**

**BT050050 Configuration**

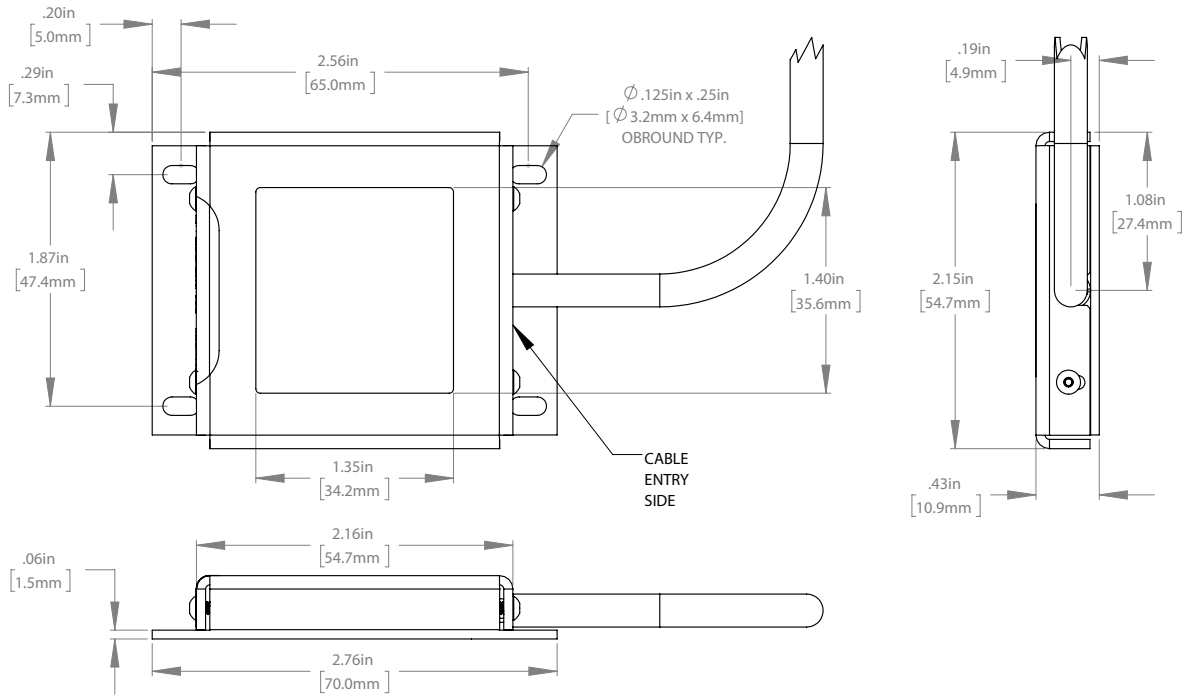

**BT100100 Configuration**

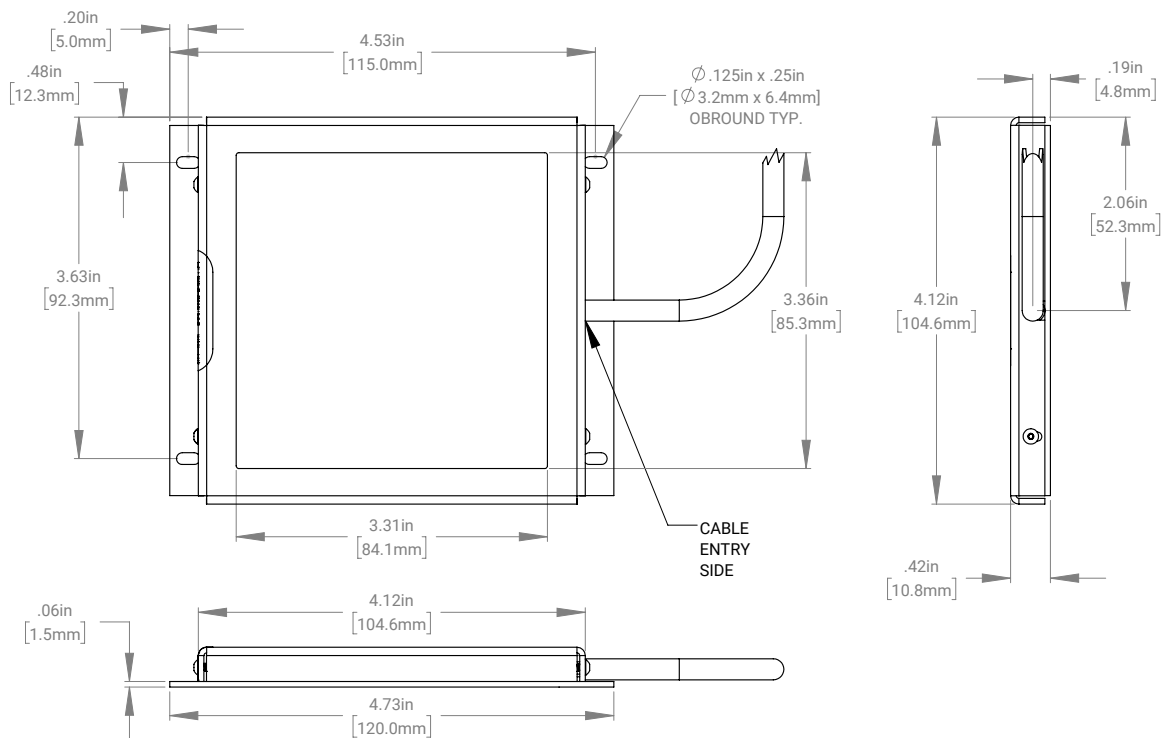

**Mechanical Information - Continued**

**Installation Drawings - Continued**

**BT200100 Configuration**

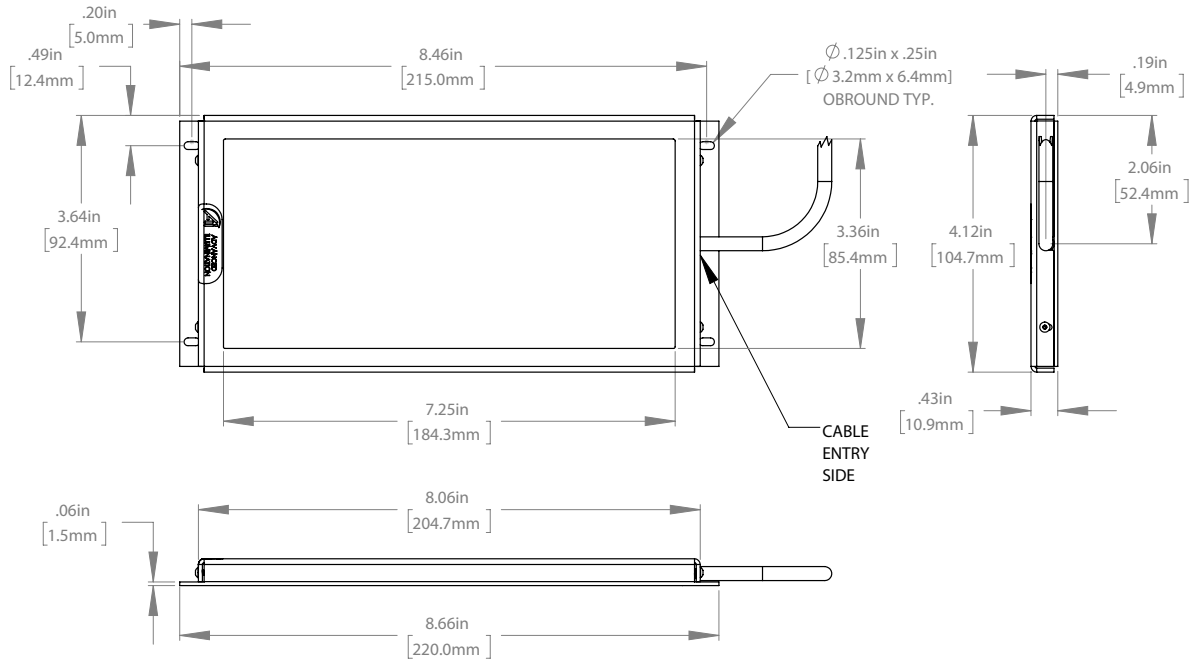

For full installation drawings and complete CAD models of this non-sealed configuration, please visit the [downloads](#) section of the product webpage.

**Electrical Information**





**Power Requirements**

**Current Required for Power Supply Sizing**







| Unit     | Wavelengths                | Configured with Standard Controller (IC, I3, I3S, C1, C5) |
|----------|----------------------------|---|
| BT050050 | WHI, 455 nm, 530nm, 625 nm | 0.340A  |
| BT050050 | 850 nm                     | 0.150A  |
| BT100100 | WHI, 455 nm, 530nm, 625 nm | 0.680A  |
| BT100100 | 850 nm                     | 0.300A  |
| BT200100 | WHI, 455 nm, 530nm, 625 nm | 1.020A  |
| BT200100 | 850 nm                     | 0.500A  |

Note: All Advanced Illumination lights and controllers are nominally powered by 24V DC unless otherwise noted. Strobe overdriving with controller based models may require more current and voltage overhead. The values above do not include background current draw from the controller (~100 mA total).

**Control Options**

| Controller Image  | Controller Details  | Connector Image   |
|---|---|---|
|   | <p><b>DCS Single Output Controller - Compatible with C1 Configurations</b><br/>PN: DCS-100E</p> <p>The DCS-100E is a compact, din-rail mounted general-purpose external controller with one C1 output connector, wired with three channels. Capable of providing single channel control or multi-channel control for RGB compatible lights.</p> <p><b>Output Power:</b> 90 W Max Continuous, 540 W Max Pulsed (Overdrive Strobe)<br/> <b>Output Current:</b> 4.5A Max Continuous, 15 A Max Pulsed<br/> <b>I/Os:</b> 3 External Trigger Inputs<br/> <b>Interface:</b> 10/100 Ethernet with Software and browser-based GUIs. SDKs are also available.</p> <p>For more information about our DCS-100E, please <a href="#">visit the controller product page</a>.</p> |   |
|  | <p><b>DCS Triple Output Controller - Compatible with C1 Configurations</b><br/>PN: DCS-103E</p> <p>The DCS-103E is a din-rail mounted general-purpose multi-light controller with three C1 output connectors. Capable of driving three lights in sync or asynchronously.</p> <p><b>Output Power:</b> 30 W Max Continuous / Output, 180 W Max Pulsed / Output<br/> <b>Output Current:</b> 1.5A Max Continuous / Output, 5 A Max Pulsed / Output<br/> <b>I/Os:</b> 3 External Trigger Inputs<br/> <b>Interface:</b> 10/100 Ethernet with Software and browser-based GUIs. SDKs are also available.</p> <p>For more information about our DCS-103E, please <a href="#">visit the controller product page</a>.</p>  |  |

**Electrical Information - Continued**

| Controller Image  | Controller Details   | Connector Image   |
|---|--|---|
|    | <p><b>Pulsar 320E High Current Controller - Compatible with C5 Configuration</b><br/> <i>PN: Pulsar 320E</i></p> <p>The Pulsar 320E is a high-power, dual output, pulse-only controller geared for overdriving driving lights at very short flash durations with very high current.</p> <p><b>Output Power:</b> 2500 W Max Pulsed / Output<br/> <b>Output Current:</b> 50 A Max Pulsed / Output<br/> <b>I/Os:</b> 2 External Trigger Inputs<br/> <b>Interface:</b> 10/100 Ethernet with Software GUI. SDKs are also available.</p> <p>For more information about our Pulsar 320E, please <a href="#">visit the controller product page</a>.</p>  |    |
|    | <p><b>Inline Controller - Continuous Only - IC Configurations</b><br/> <i>PN: N/A</i></p> <p>The IC is an inline, cable-mounted continuous-only controller configured/wired directly for the ordered light head.</p> <p><b>Output Power:</b> 25 W Max Continuous<br/> <b>Output Current:</b> 1.25 A Max Continuous<br/> <b>I/O:</b> 1 0-10 V Analog Dimming Input<br/> <b>Interface:</b> Direct Cable (flying leads or optional connector)</p> <p>For more information about our IC Controller please <a href="#">visit the controller product page</a>.</p>   |    |
|  | <p><b>Inline Controller - Strobe and Continuous - I3 &amp; I3S Configurations</b><br/> <i>PN: N/A</i></p> <p>The I3 and I3S are inline, cable-mounted continuous and pulse (overdrive strobe) capable controllers configured/wired directly for the ordered light head. When operated in pulsed mode, the I3 is a default-on device on power up, whereas the I3S is default-off, requiring a trigger to illuminate.</p> <p><b>Output Power:</b> 25 W Max Continuous, 125 W Max Pulsed<br/> <b>Output Current:</b> 1.25 A Max Continuous, 8 A Max Pulsed (Load Dependent)<br/> <b>I/Os:</b> 1 Gated Trigger Signal, 1 0-10 V Analog Dimming Input<br/> <b>Interface:</b> Direct Cable (flying leads or optional connector)</p> <p>For more information about our I3/I3S Controller, please <a href="#">visit the controller product page</a>.</p> |  |

**Electrical Information - Continued**

**Inline Control Option Wiring Information**

**Standard Flying Lead and Optional M12 Connector Pinout Functions**

| Pin (M12) | Wire Color   | 24V Functions | IC Functions         | I3/I3S Functions        | I4 Functions            | M12 Pinout  |
|-----------|--------------|---------------|----------------------|-------------------------|-------------------------|---|
| 1         | <b>BROWN</b> | 24V DC        | 24V DC               | 24V DC                  | 24 V DC                 |  <p><b>5-Position Male Connector</b></p> |
| 2         | <b>WHITE</b> | N/A           | 0-10V Analog Control | Reserved                | NPN/Active Low Trigger  |   |
| 3         | <b>BLUE</b>  | DC GND        | DC GND               | DC GND                  | DC GND                  |   |
| 4         | <b>BLACK</b> | N/A           | Gate Low             | PNP/Active High Trigger | PNP/Active High Trigger |   |
| 5         | <b>GRAY</b>  | N/A           | N/A                  | 0-10V Analog Control    | 0-10 V Analog Dimming   |   |

The functions above are only applicable when ordering an 24, IC, I3, I3s, or I4 power configuration with our without an M12 connector. For more wiring information pertaining to strobing and dimming functionality, please download the controller manuals and datasheets.

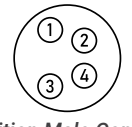

**Optional M8 Connector Pinout Functions**

| Pin (M8) | Wire Color   | 24V Functions | IC Functions         | I3/I3S Functions    | I4 Functions        | M8 Pinout   |
|----------|--------------|---------------|----------------------|---------------------|---------------------|---|
| 1        | <b>BROWN</b> | 24V DC        | 24V DC               | 24V DC              | 24 V DC             |  <p><b>4-Position Male Connector</b></p> |
| 2        | <b>WHITE</b> | N/A           | 0-10V Analog Control | Reserved            | Active Low Trigger  |   |
| 3        | <b>BLUE</b>  | DC GND        | DC GND               | DC GND              | DC GND              |   |
| 4        | <b>BLACK</b> | N/A           | Gate Low             | Active High Trigger | Active High Trigger |   |







The functions above are only applicable when ordering an 24, IC, I3, I3s, or I4 power configuration with our without an M8 connector. For more wiring information pertaining to strobing and dimming functionality, please download the controller manuals and datasheets.

**Accessories**

Advanced Illumination offers a variety of accessories designed to pair with our lighting and control products. Below you will find a table of accessories which are compatible with many configurations of the BT series.

| Category            | Accessory Image   | Accessory Detail   |
|---------------------|---|--|
| <b>Power Supply</b> |  | <p><b>24 Volt DC Power Supply</b><br/>PN: PS24-TL</p> <p>This convenient power source is a universal AC input switching power supply with a regulated output DC current. The power supply comes with an LED Power Indicator, tinned leads marked Positive (+) and Negative (-) and 2 WAGO connectors for simplified assembly.</p> <p>For more information about our 24 Volt DC Power Supply, please <a href="#">visit this webpage</a>.</p>  |
| <b>Dimmer</b>       |  | <p><b>Manual Dimming Accessory for the IC, I3, I3s and I4</b><br/>PN: DCS-MP</p> <p>The DCS-MP is a 30-position potentiometer, detented for precision level control and provides repeatable dimming with cable inline controllers. Features include DIN-rail mountable, a flip up cover to prevent accidental adjustments, spring clamp wiring terminal for flying leads or an M12 connector for use with the IC, I3/I3S or I4 Inline Controllers.</p> <p>For more information about our Manual Dimming Accessory please <a href="#">visit this webpage</a>.</p> |

**Electrical Information - Continued**

| Category        | Accessory Image   | Accessory Detail   |
|-----------------|---|--|
| Dimmer          |    | <p><b>Manual Dimming Accessory for the IC</b><br/>PN: MP-ICS</p> <p>The MP-ICS is a dimmer which is designed for use on lights with the IC Inline Controller. This unit provides for 0 – 100% intensity control. It is NOT COMPATIBLE with LLI37, BLI38, LLI67, and BLI68 "IC" Lights or lights built with the "24v controller" option.</p> <p>For more information about our Manual Dimming Accessory, please <a href="#">visit this webpage</a>.</p>   |
| Extension Cable |    | <p><b>DCS-100E/103E Extension Cable, Single Light Power Cable - C1 Configuration</b><br/>PN: LC-XX-S</p> <p>This extension cable was designed for applications requiring power cables longer than the standard 2 meters provided with Ai lights. This single light cable features a single male and single female 7 pin locking connector (C1) and can be purchased in 3 - 15-meter lengths.</p> <p>For more information about our DCS-100E/103E Extension Cable, Single Output, please <a href="#">visit this webpage</a>.</p>  |
| Extension Cable |    | <p><b>DCS-100E/103E Extension Cable, Dual Light Power Cable - C1 Configuration</b><br/>PN: LC-XX-Y</p> <p>This extension cable was designed for applications requiring two identical lights to be powered through a single controller. These Y cables feature a single male and dual female 7 pin locking connectors (C1) and can be purchased in 3 - 15-meter lengths. See attached spec sheet for compatible light configuration.</p> <p>For more information about our DCS-100E/103E Extension Cable, Split Output, please <a href="#">visit this webpage</a>.</p>      |
| Extension Cable |  | <p><b>Pulsar 320E Extension Cable - C5 Configuration</b><br/>PN: LC-XX-S-C5</p> <p>This extension cable was designed for applications requiring power cables longer than the standard 2 meters provided with Ai lights. This single light cable features a single male and single female Pulsar 320 connector (C5) and can be purchased in 3 - 15 meter lengths.</p> <p>For more information about our Pulsar 320E Extension Cable, please <a href="#">visit this webpage</a>.</p>   |
| Adaptor Cable   |  | <p><b>Cognex Gen2 Inline Controller Adaptor Cable</b><br/>PN: AD-I3-CGX2</p> <p>This cable adaptor is for connecting I3/I3S configured lights with Cognex Gen2 Cameras, and comes with a male to female M12 connectors.</p> <p>For more information about our Cognex Gen2 Inline Controller Adaptor Cable, please <a href="#">visit this webpage</a>.</p>  |
| Filters         |  | <p><b>Camera Lens Band Pass Filters</b><br/>PN: BPXXX-YYY</p> <p>Eliminating all but a narrow band of light (+/- 40nm) centered on the specified wavelength, band pass filters are used to enhance colors, or to stop unwanted ambient light from reaching the camera. Filtering can replace existing shrouds, simplifying the physical set up of an inspection site. Ai offers 635nm and 660nm band pass filters to fit several different lens sizes.</p> <p>For more information about our Camera Lens Band Pass Filters, please <a href="#">visit this webpage</a>.</p> |

## Additional Information

### Warranty

Every Advanced illumination, Inc. (Ai) product is thoroughly inspected and tested before leaving the factory. Products are warranted to be free of defects in workmanship and materials for a period of FIVE YEARS from the original date of purchase. Should a defect develop during this period, customers may return the complete product, freight prepaid, to one of Ai's distributors or to the Ai factory. All product warranty returns require a Return Merchandise Authorization (RMA) number which is obtained from Customer Service. The RMA number must be clearly marked on the outside of the package. Ai will inspect the unit, and if a defect is found will, at our option, repair or replace the product without charge. Ai disclaims liability for any implied warranties, including implied warranties of "merchantability" and "fitness for a specific purpose." For products under warranty that have since been discontinued, Ai will make an effort to replace with equivalent parts; for circumstances that do not allow for equivalent replacement, Ai reserves the right to repair or replace these products with an updated version. Ai cannot be held responsible for the unauthorized or inappropriate use of its products. Any unauthorized repair or modifications will result in a voided warranty. No Liability for Consequential Damages: In no event shall Ai be liable for any consequential, special, incidental, or indirect damages of any kind arising from the sale or use of the products.

### Compliance

Our lighting products are designed and tested to meet CE, RoHS, and IEC standards. As a global ISO 9001 certified company, we understand the importance of compliance and perform accelerated testing on every product before shipment. For more information on our compliance standards, please see our compliancy documentation here: <https://www.advancedillumination.com/services/compliance-statements/>

### Electromagnetic Compatibility

This product was tested and complies with the regulatory requirements and limits for electromagnetic compatibility (EMC) as stated in the product specifications. These requirements and limits are designed to provide reasonable protection against harmful interference only when the product is operated in its intended industrial electromagnetic environment. To minimize the potential for electromagnetic interference or unacceptable performance degradation, install and use this product in strict accordance with the instructions in the product documentation.

### Customer Service

For information on existing orders, or to make an order adjustment, contact us Monday through Friday 8:00 am to 5:00 pm ET or send an email to [orders@advancedillumination.com](mailto:orders@advancedillumination.com).

### Company Information

Advanced Illumination  
440 State Garage Road, Rochester, VT 05767  
Phone: +1 (802) 767 3830  
Fax: +1 (802) 767 2636  
Email: [info@advancedillumination.com](mailto:info@advancedillumination.com)  
Web: [advancedillumination.com](http://advancedillumination.com)  
© 2023 Advanced illumination Inc. All rights reserved